

Feder	Potentialtabelle Bu 17
1	30 V Sinus fest
2	+ 350 V
3	Masse
4	12,6 V~
5	180 V~
6	z. Schalter „Meß.-Abfr.“ i. OSZ 62
7	180 V~
8	z. Schalter „Meß.-Abfr.“ i. OSZ 62, bzw. 30 V Sinus gedreht v. EAG 62
9	Sägezahn v. EAG 62
10	Dunkelpunkt z. OSZ 62

Feder	Potentialtabelle Bu 18
1	Sinus z. IG 62
2	+ 350 V
3	Masse
4	12,6 V~
5	180 V~
6	z. Relais i. IG 62
7	180 V~
8	+ 12 V
9	180 V~
10	v. Höh.-Potentiometer

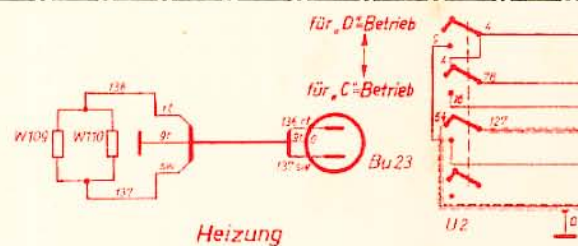
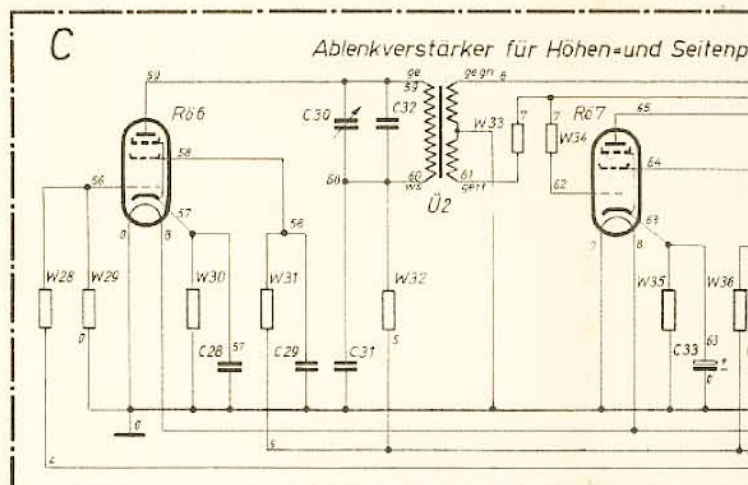
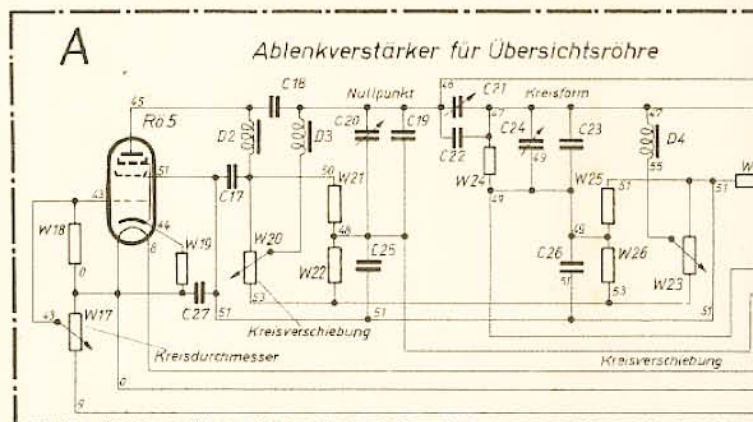
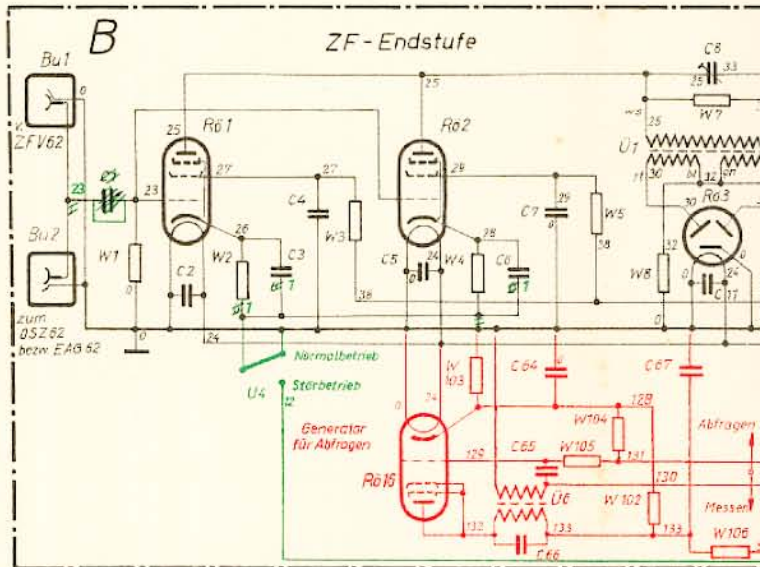

Schaltbild

(über die farbig gezeichneten Teile s. Blatt F 014-8)

Werkstatt

Nr. 69

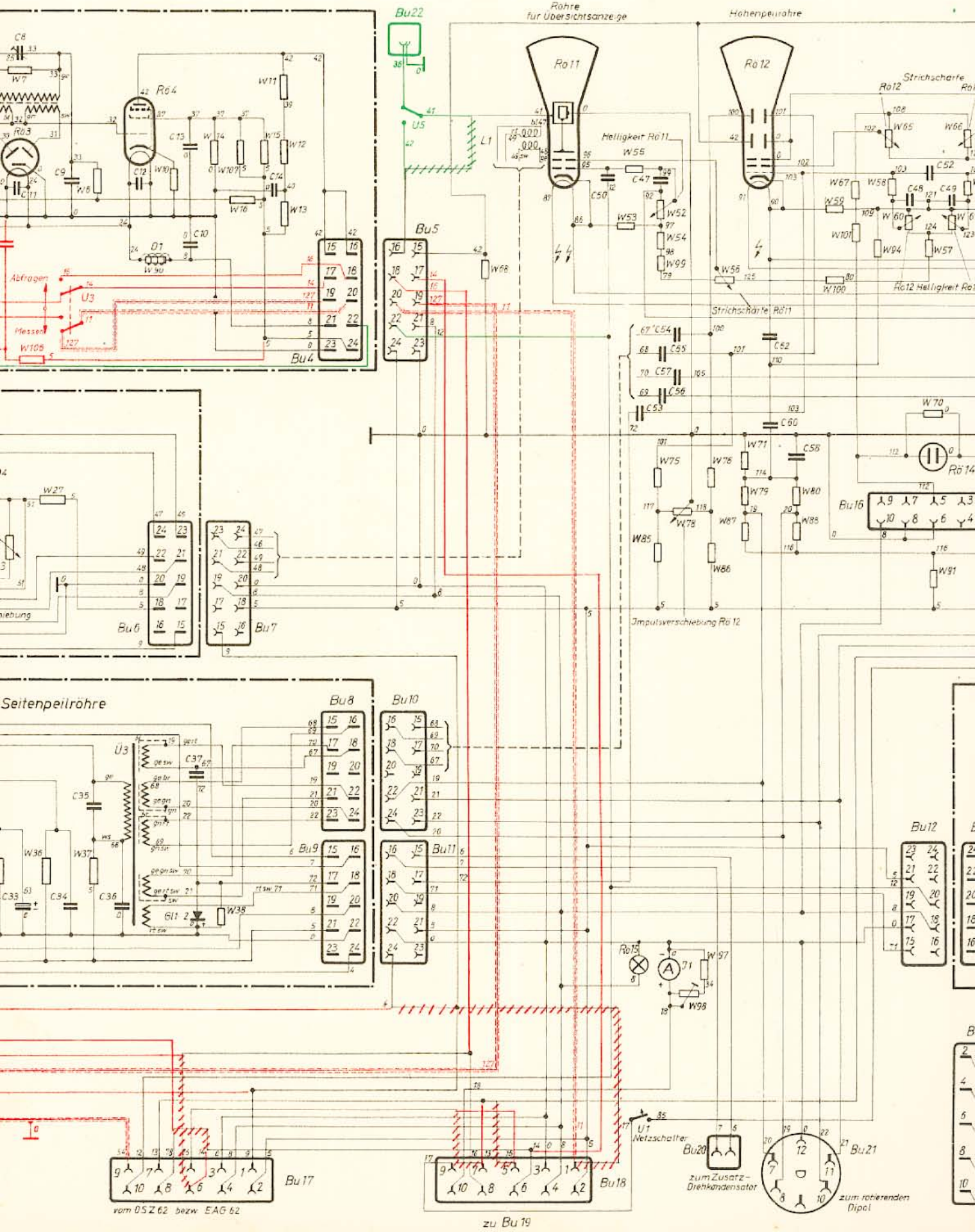

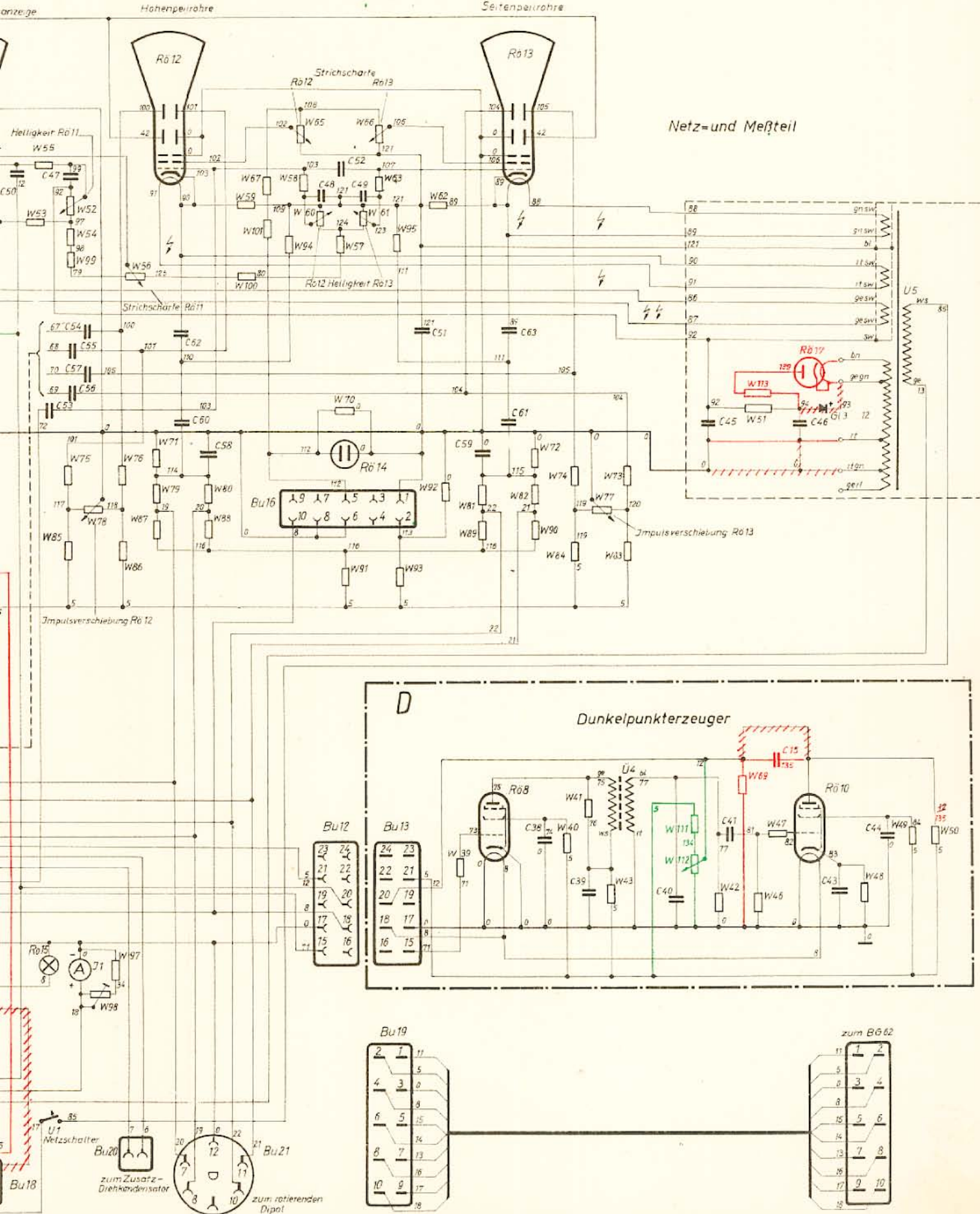

anzeige

Höhenpeilrohre

Seitenpeilrohre

Netz- und Meßteil

Dunkelpunkterzeuger

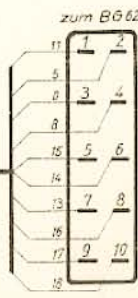
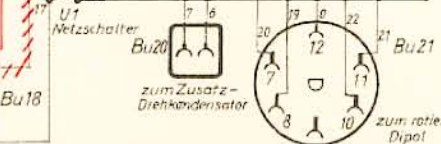

zum B6.62